

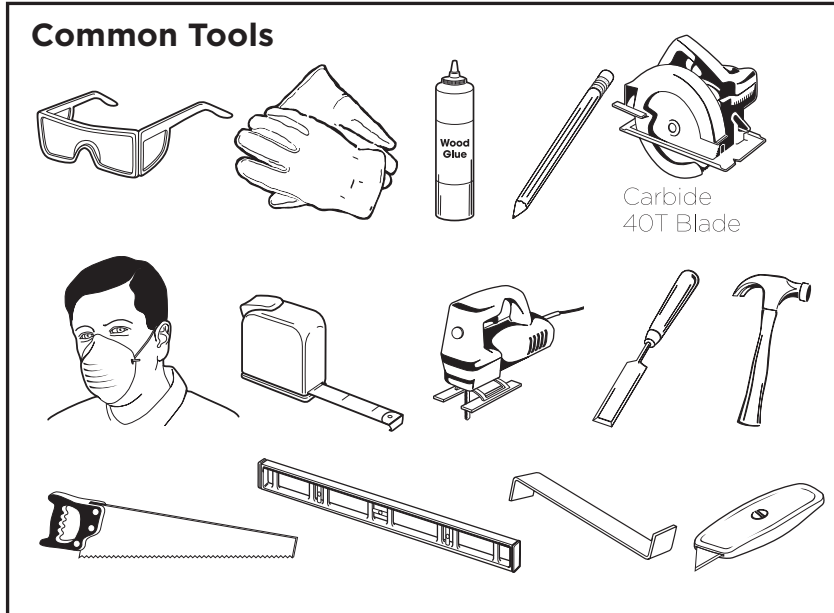

SplashDefense™ Floor Installation Instructions

Tools Required for Installation



Job Site

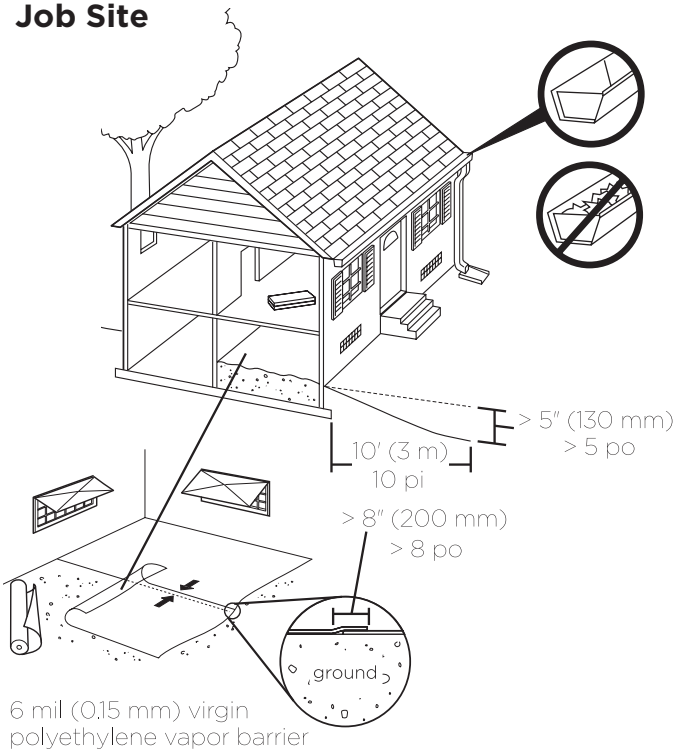

Site Requirements

Laminate is a durable floor covering, not intended as structural material. Laminate requires a clean, dry, secure subfloor that meets building codes.

The following requirements are not intended to supersede federal, state or local building codes, but as with many other interior finish products, may require modifying existing structural components for successful installation. Owner assumes responsibility for compliance with all building codes.

Laminate floor is suitable for use in climate controlled (35-65% RH and 60-85° F) indoor installations only and should not be installed in rooms with floor drains or sump pumps. Laminate floor can be installed above, on or below grade.

A moisture test is strongly recommended to determine if high moisture exists in the subfloor. When using a calcium chloride moisture test for concrete subfloors (ASTM 1869), values must be ≤ 5 lbs/1000ft²/24-hr or <80% RH with an in situ probe (ASTM F2170). Moisture readings of wood subfloors must be ≤ 12%.

Acceptable job site conditions, including relative humidity and subfloor moisture conditions, must be maintained throughout the lifetime of the flooring.

Laminate flooring is installed as a floating floor and requires the use of T-moldings in doorways 4 ft (1.22m) or less and in rooms 40 feet (12.2 m) or larger in length or width. Floor movement must not be constrained by glue, nails, screws, hardware or other fixed obstructions.

This product must be installed in accordance with these installation instructions.

For product and installation assistance, call 888-459-9220.

SplashDefense™ Floor Installation Instructions

Site and Material Preparation

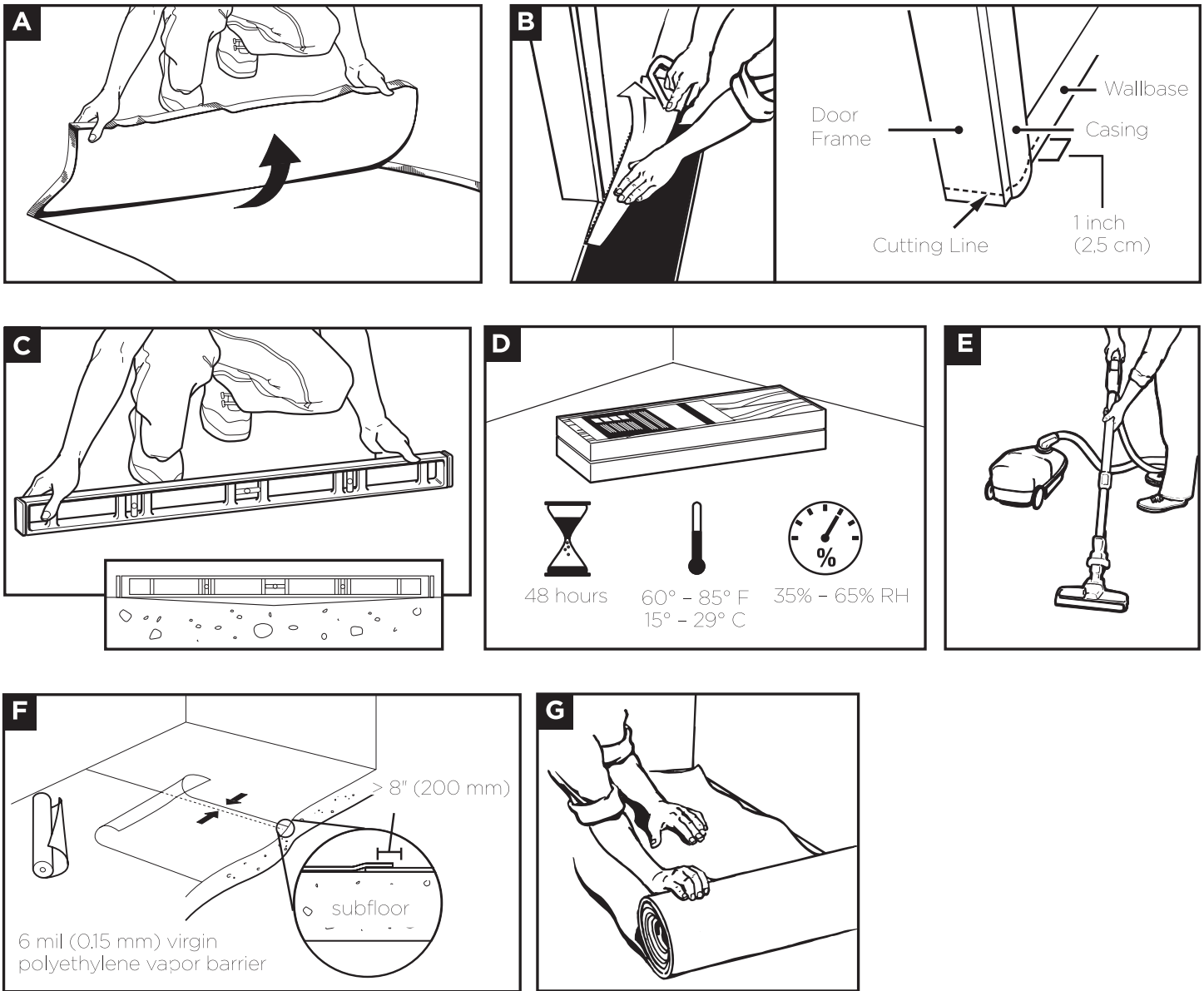

Site and Material Preparation

- Remove carpet and padding. Also remove any wood flooring installed on concrete. Do not remove products unless they are asbestos-free.
- Undercut door frame and wallbase. Slide the flooring at least 1/4" underneath the door frame and wallbase. Also leave a concealed 3/8" minimum expansion space under each.
- Remove bumps or peaks in subfloor and fill depressions with floor leveling compound to ensure no more than 3/16" unevenness per 10-foot span.
- Acclimate unopened product before installation. If there is no time for acclimation, **there should be no more than a difference of 25° F and 20% relative humidity between the stocking/transportation environment of the flooring and the final installation environment of the flooring.**
- Clean debris from subfloor before installation.
- For concrete subfloors, install vapor barrier with overlapped seams of 8" or more.
- For planks without attached underlayment,** install over single layer of underlayment appropriate for laminate floors.

SplashDefense™ Floor Installation Instructions

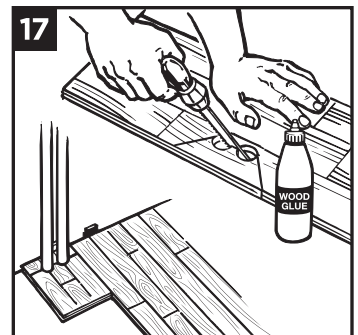
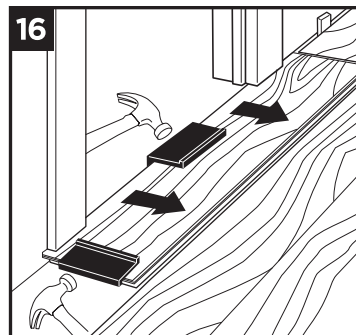
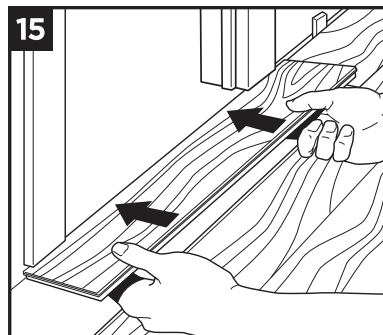
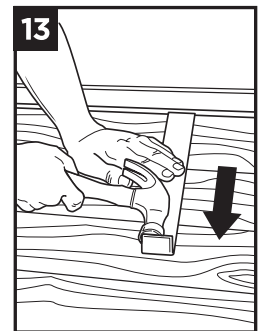
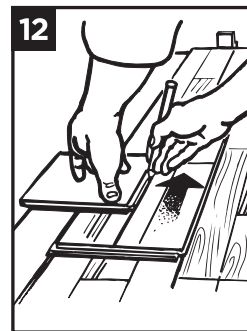
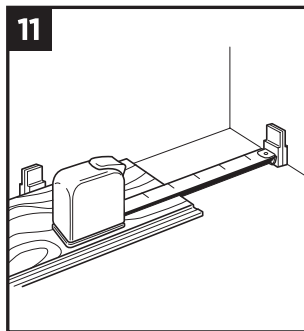
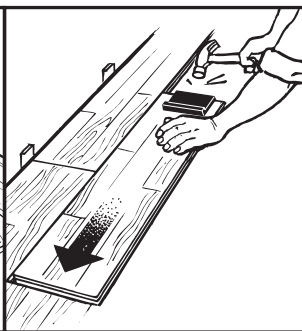
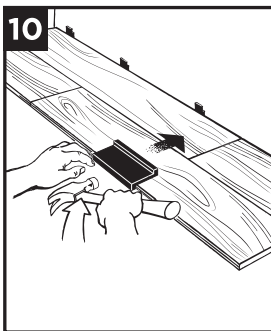
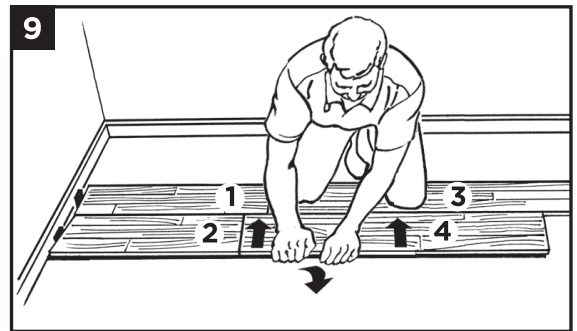
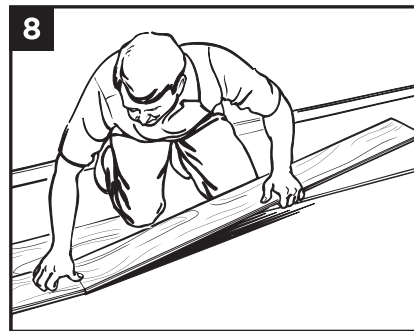
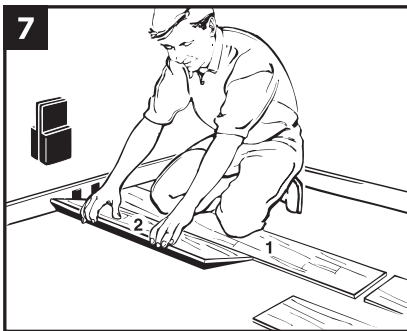
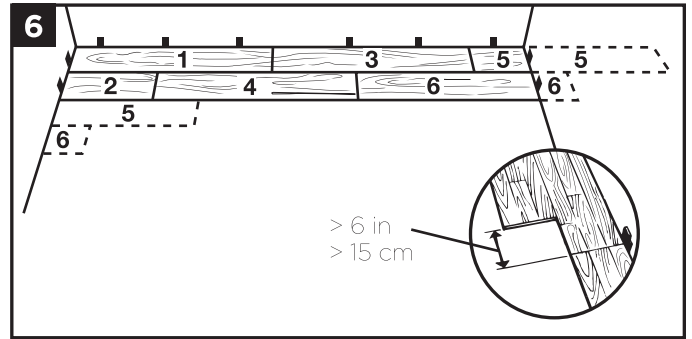
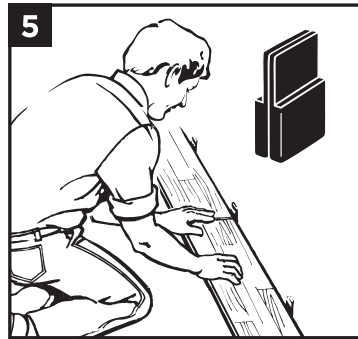
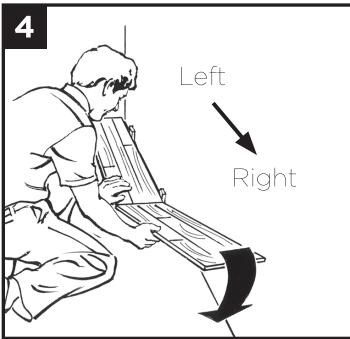
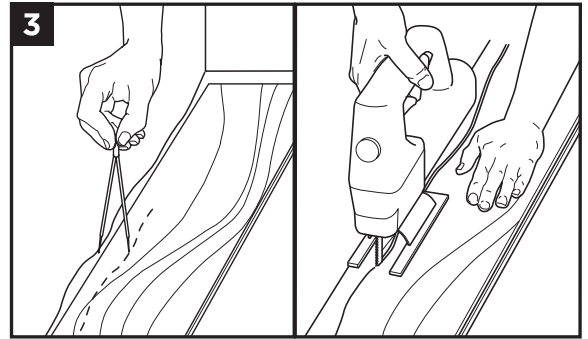
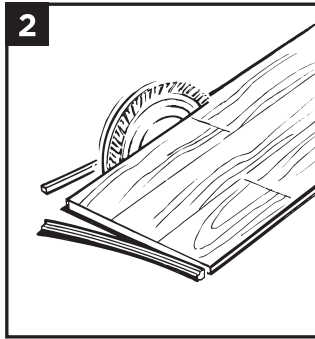
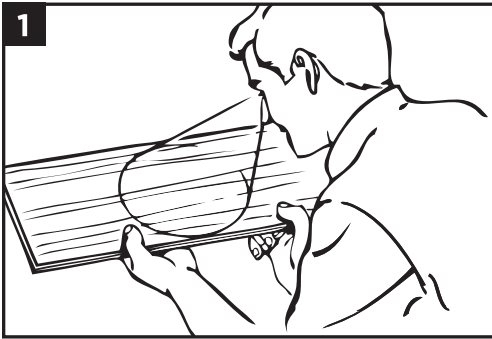

SplashDefense™ Floor Installation Instructions

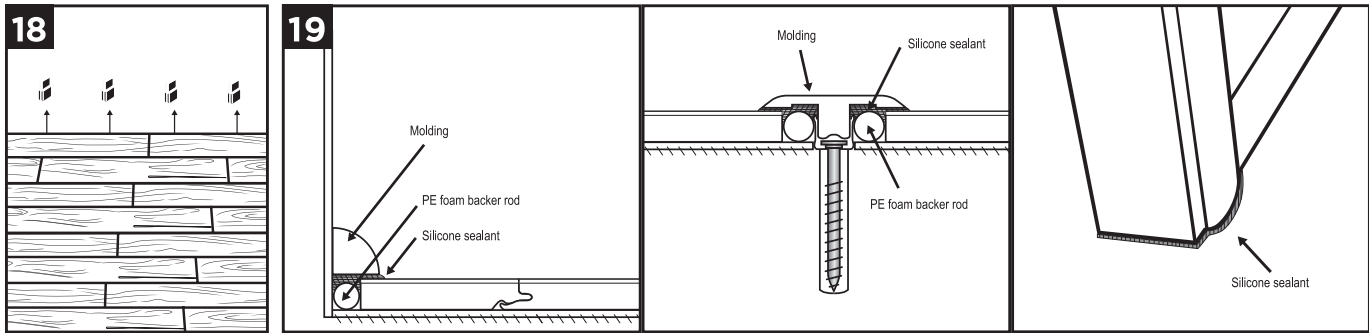

Flooring Installation

1. Inspect each plank. Floor should be installed blending planks from several cartons at the same time to ensure good color and shade mixture throughout the installation.
2. For the first row along straight walls, remove the tongue on all long side joints and on the short side of the 1st plank only.
3. For uneven walls, trace contour on tongue-side of plank and cut.
4. Assemble the first row tongue side toward wall. Insert the end tongue into the end groove and rotate downward to assemble. Keep the planks aligned and the joints closed.
5. Two spacers thick side to thick side = $\frac{3}{8}$ ".
6. Provide a $\frac{3}{8}$ " space for expansion on all sides. First piece must be at least 8" long. Start new rows with pieces trimmed from previous row. Ensure at least a 6" end joint offset.
7. At a slight angle, insert the tongue of plank 2 into the groove of plank 1 until the laminate edges meet, and then rotate down until the joints lock.
8. Join the short end of the plank first. There will be a gap on the long side joints when the plank is rotated down.
9. Raise the outside edge of the plank upward approximately 1". Maintain this angle as you push the plank in until the laminate edges meet. Rotate downward on the plank until the joint locks. Repeat these steps to complete the installation. **Installation Tip: Place a carton of planks across the end of the row being installed to keep installed planks in place during installation.**
10. **Alternate Tap Method:** Align the tongues into the grooves of the long and short sides of the planks. Install the long side first with a tapping block by tapping lightly along the long side until the joint is closed tightly. Then tap the end using the tapping block into a locked position. **Note: Uneven tapping or use of excessive force may damage the joint.**
11. Ensure there will be a $\frac{3}{8}$ " gap (after the joint is closed) to the wall for expansion.
12. For the last row, align the plank to be used on top of the 2nd to last row. Using a full width plank as a spacer, trace wall contour and cut plank.
13. For the last row, install the long side tongue into the groove with the end joint aligned. Using a pull bar and hammer, work evenly along the length of the plank and lightly tap the joint closed.
14. After tapping the long side joint closed, tap the short side closed, using a tapping block or a pull bar.

Installation Under Doorway Frames

15. Slide plank under pre-cut door frame.
16. Tap the long side joint closed first. Then tap the end joint closed.

Installation Around Fixed Objects (such as Pipes)

17. Allow $\frac{3}{8}$ " expansion space around pipes or other fixed objects.

Finishing the Installation

18. Remove all spacers.
19. Create a watertight seal by applying flexible 100% silicone sealant to the entire perimeter of the installation. **DO NOT** use acrylic sealant.
 - First fill all expansion spaces with $\frac{3}{8}$ " compressible PE foam backer rod and cover with silicone sealant.
 - Prior to installing the moldings, apply silicone sealant to the portion of the molding or transition that will contact directly with the laminate flooring surface.
 - Install moldings and immediately wipe away any excess silicone sealant.
 - Apply silicone sealant at connections to doorframes or any other fixed objects.

SplashDefense™ Floor Installation Instructions

Care and Cleaning

Place felt floor protectors under legs of moveable furniture. Chair casters should be rubber — not plastic or metal. Place walk-off mats at entrances. Dust mop as primary cleaning method. Occasionally wet mop with water only, using a well wrung out mop; **DO NOT** pour liquid directly on floor or use an excessively wet mop that will puddle or leave moisture standing on the floor. If needed, use a solution of 1 cup of vinegar per gallon of water OR 1/3 cup non-sudsing ammonia per gallon of water. **DO NOT** use detergents, abrasive cleaners, soaps, waxes or polishes. Use correct hard surface vacuum tools. **DO NOT** use rotating beater bars, floor scrubbers, steamers, jet mops, buffers or similar products. Wipe up spills immediately. **DO NOT allow topical moisture to remain on the floor longer than the time specified in the product warranty.**

IMPORTANT HEALTH NOTICE FOR MINNESOTA RESIDENTS ONLY:

THESE BUILDING MATERIALS EMIT FORMALDEHYDE. EYE, NOSE, AND THROAT IRRITATION, HEADACHE, NAUSEA AND A VARIETY OF ASTHMA-LIKE SYMPTOMS, INCLUDING SHORTNESS OF BREATH, HAVE BEEN REPORTED AS A RESULT OF FORMALDEHYDE EXPOSURE. ELDERLY PERSONS AND YOUNG CHILDREN, AS WELL AS ANYONE WITH A HISTORY OF ASTHMA, ALLERGIES, OR LUNG PROBLEMS, MAY BE AT GREATER RISK. RESEARCH IS CONTINUING ON THE POSSIBLE LONG-TERM EFFECTS OF EXPOSURE TO FORMALDEHYDE. REDUCED VENTILATION MAY ALLOW FORMALDEHYDE AND OTHER CONTAMINANTS TO ACCUMULATE IN THE INDOOR AIR. HIGH INDOOR TEMPERATURES AND HUMIDITY RAISE FORMALDEHYDE LEVELS. WHEN A HOME IS TO BE LOCATED IN AREAS SUBJECT TO EXTREME SUMMER TEMPERATURES, AN AIR-CONDITIONING SYSTEM CAN BE USED TO CONTROL INDOOR TEMPERATURE LEVELS. OTHER MEANS OF CONTROLLED MECHANICAL VENTILATION CAN BE USED TO REDUCE LEVELS OF FORMALDEHYDE AND OTHER INDOOR AIR CONTAMINANTS. IF YOU HAVE ANY QUESTIONS REGARDING THE HEALTH EFFECTS OF FORMALDEHYDE, CONSULT YOUR DOCTOR OR CALL LOCAL HEALTH DEPARTMENT.

Full warranty text is available at www.harmonics-flooring.com and through 1-888-459-9220.

For service under this warranty please contact HARMONICS® at 1-888-459-9220 or at www.harmonics-flooring.com.

HARMONICS® Flooring is manufactured and distributed by Unilin North America LLC

550 Cloniger Drive
Thomasville, NC 27360

www.harmonics-flooring.com